

ARU20x

User Manual



www.audac.eu

ADDITIONAL INFORMATION

This manual is put together with much care, and is as complete as could be on the publication date. However, updates on the specifications, functionality or software may have occurred since publication. To obtain the latest instruction manual or obtain additional product information, please visit the product page on www.audac.eu. For information about software version updates, please visit www.audac.eu/software.

Index

Introduction	5
Precautions	6
Safety requirements	6
Caution servicing	6
EC Declaration of Conformity	6
Waste of Electrical and Electronic Equipment (WEEE)	7
Caution	7
Chapter 1: Pin connections and connectors	9
Connection standards	9
Chapter 2: ARU20x Overview	10
Connection description	10
Contact description	11
Internal settings	12
Connections overview	14
Chapter 3: Wiring up the system	15
Chapter 4: Application examples	16
Chapter 5: User interface & configuration	17
Login	17
Dashboard	18
Events	19
Settings	20
Chapter 6: IP basics	24
Chapter 7: Technical specifications	26

Introduction

Multi channel digital relay units

The ARU20x series are multi channel digital relay units which are especially designed with flexibility and functionality in mind. Various ways of switching the relays are provided, including an integrated web interface, optional paging consoles and analog contact triggering making the ARU20x AUDAC's smartest and most innovative relay modules.

With this ingenious device, switching between audio sources, signal routing, and even customized automation setups are obtainable. The bipolar relays allow switching of balanced mono signals as well as unbalanced stereo signals. Normal open and normal closed contacts are provided as well.

Thanks to its modular nature, the ARU20x is perfectly suitable for small home or retail applications as well as big installations. There is no limit to the amount of ARU's connected to one system. The TCP/IP functionality allows controlling the ARU20x over an existing ethernet network through an integrated HTML5 webserver, achieving full control via any connected PC, laptop or smart device. An RS485 control port allows them for being integrated with any matrix or other controlling system.

They are housed in a DIN rail mountable enclosure, guaranteeing an easy and clean installation and integration in electrical cabinets. The front of the black ABS housing provides a brief overview of its connection possibilities, while the back is equipped with a spring mount mechanism allowing easy mounting on widely available standard DIN rails. This way it's possible to easily integrate it in any electrical cabinet.

Precautions

READ FOLLOWING INSTRUCTIONS FOR YOUR OWN SAFETY

ALWAYS KEEP THESE INSTRUCTIONS. NEVER THROW THEM AWAY

ALWAYS HANDLE THIS UNIT WITH CARE

HEED ALL WARNINGS

FOLLOW ALL INSTRUCTIONS

NEVER EXPOSE THIS EQUIPMENT TO RAIN, MOISTURE, ANY DRIPPING OR SPLASHING LIQUID. AND NEVER PLACE AN OBJECT FILLED WITH LIQUID ON TOP OF THIS DEVICE.

DO NOT INSTALL THIS UNIT NEAR ANY HEAT SOURCES SUCH AS RADIATORS OR OTHER APPARATUS THAT PRODUCE HEAT

DO NOT PLACE THIS UNIT IN ENVIRONMENTS WHICH CONTAIN HIGH LEVELS OF DUST, HEAT, MOISTURE OR VIBRATION

THIS UNIT IS DEVELOPED FOR INDOOR USE ONLY. DO NOT USE IT OUTDOORS

PLACE THE UNIT ON A STABLE BASE OR MOUNT IT IN A STABLE RACK

ONLY USE ATTACHMENTS & ACCESSORIES SPECIFIED BY THE MANUFACTURER

UNPLUG THIS APPARATUS DURING LIGHTNING STORMS OR WHEN UNUSED FOR LONG PERIODS OF TIME



CAUTION – SERVICING

This product contains no user serviceable parts. Refer all servicing to qualified service personnel. Do not perform any servicing (unless you are qualified to)



EC DECLARATION OF CONFORMITY

This product conforms to all the essential requirements and further relevant specifications described in following directives: 2014/30/EU (EMC) and 2014/35/EU (LVD)



WASTE ELECTRICAL AND ELECTRONIC EQUIPMENT (WEEE)

The WEEE marking indicates that this product should not be disposed with regular household waste at the end of its life cycle. This regulation is created to prevent any possible harm to the environment or human health.

This product is developed and manufactured with high quality materials and components which can be recycled and/or reused. Please dispose this product at your local collection point or recycling centre for electrical and electronic waste. This will make sure that it will be recycled on an environmentally friendly manner, and will help to protect the environment in which we all live.

Chapter 1

Pin connections and connectors

CONNECTION STANDARDS

The in- and output connections for AUDAC audio equipment are performed corresponding to international wiring standards for professional audio equipment.

RJ45 (RS485, Audio, +24V DC):

For connection to paging consoles and/or other RS485 peripheral equipment

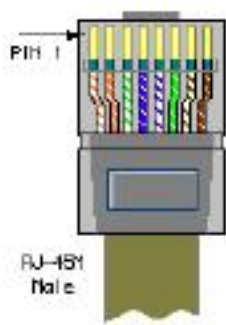

Pin 1	White–Orange	Not used
Pin 2	Orange	Not used
Pin 3	White–Green	+24V DC
Pin 4	Blue	RS485 A
Pin 5	White–Blue	RS485 B
Pin 6	Green	GND
Pin 7	White–Brown	Paging audio +
Pin 8	Brown	Paging audio –

Audio signal inputs and outputs must be connected with high-quality audio cable and high-quality connectors.

RS485 / TCP/IP

The ARU20x has RS485 and TCP/IP control ports which all accept the same commands. The complete command set to control the ARU20x is available in the commands user manual which is freely downloadable on www.audac.eu

Chapter 2

ARU20x Overview

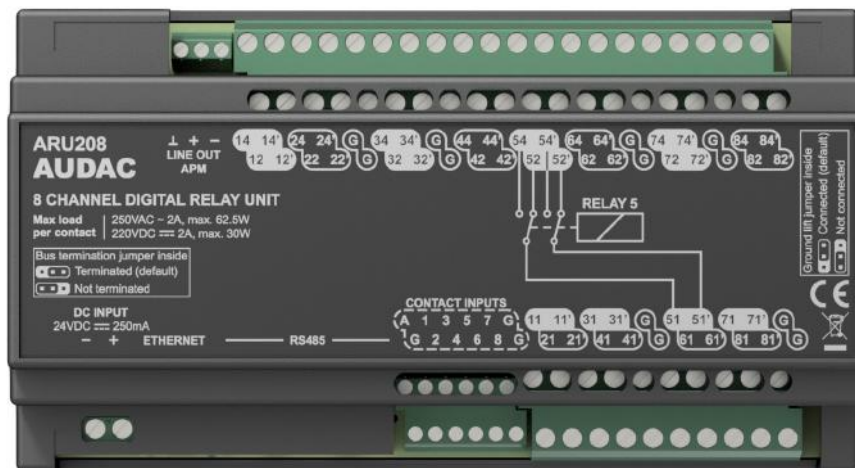

Connections description

Power supply (24V DC):

A 24 Volts power supply connection is provided on the left side of the ARU20x. An external power supply should be connected to these terminal block connectors for powering the device. Pay attention to the correct voltage and polarity when connecting the power supply.

Ethernet:

The ARU20x can be connected to an IP network using the 'Ethernet' RJ45 connector. When connected in an IP network, all functions can be accessed over the network including configuration, monitoring and control. The control of the system is possible through the integrated HTML5 web-page which runs on the integrated web server, while control through commands or the Audac Touch™ application is also possible. To ensure a reliable connection, always use CAT5E (or better) cabling and 10 Mbit compatible network infrastructure.

RS485:

The RS485 databus is connected using RJ45 connectors and allows integration of the ARU20x in any RS485 controlled system. It allows integration with peripheral devices connected to your audio system or any other RS485 based network. The ARU208 contains two RS485 connections allowing daisy chaining of multiple units. The RS485 shall be terminated using a bus termination jumper at the end of the line. More information about this can be found in the next chapter.

Contacts inputs:

The contact inputs on the ARU20x are dry contact inputs which can be used for triggering relays by external devices or actuators. These analogue dry contacts priority over the digital functions / triggers. Typical applications are activations by external buttons, switches or alarm contacts. Activation is done by making a contact between the ground and the contact for the particular relay. When triggering the 'A' contact, all contacts will switch simultaneously.

NOTE

The use of the dry contact inputs will priority over the digital control functions. There won't be any direct feedback or monitoring possible through to the digitally controlling devices. All connects must be "dry" contacts (voltage free)

Relay input contacts:

The relay input connections are available on the upper side of the ARU20x and are marked with the x2 (x2') and x4 (x4') indicators. The x2 marked contacts are normally closed contacts, while the x4 marked contacts are normally open contacts.

Relay output contacts:

The relay output connections are available on the lower side of the ARU20x and are marked with the x1 and x1' indicators where the 'x' stands for the relay number. Both contacts with the same number are switched by the same relay.

Ground contacts:

When switching differential signals, the ground (common) shall be connected to the 'G' terminals.

Contact description

Line output APM:

When an APM1xx series paging console is connected to the 'RS485' databus, the analogue line output signal from the paging console is available on this terminal. The line output is a balanced audio signal.

This signal shall be fed to all the relay inputs which are meant for switching the paging audio signal to the outputs and the connection should be done by external wiring. When connecting the analogue output signal to an external amplifier, this terminal should be used as well.

Music / paging input:

All contact pairs are labelled with a double digit number, the first number indicates the relay number, the second number indicates the type of contact. An example of such contact configuration (relay 5) is shown below, contact 51 is connected to 52 for a normal closed connection and 54 for a normal open connection.

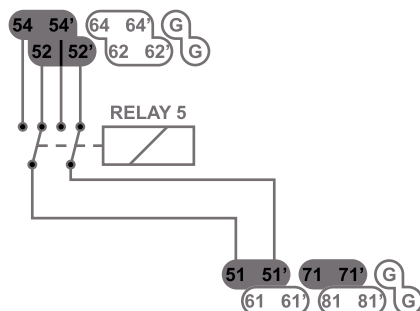

Connections	
x1	Out
x2	NC
x4	NO
G	Ground

Multiple simultaneous connections (NO and NC) are possible. In neutral position, the relay will return back to its idle state, which has the normal closed contacts enabled (contacts x2). Same situation will happen in case of a power shutdown, which makes the relay return back to the idle state, meaning contacts x2 are connected.

Internal settings

The following settings are configurations which might be required to get configured one single time when setting up / configuring the system. They are configured through jumpers which are located on the PCB of the ARU20x housing, requiring the top cover from being removed before making any adjustment.

ATTENTION



These settings are only allowed to be made by qualified technicians and the system must be fully disconnected before any of these adjustments are being made.

Bus termination jumper:

When multiple ARU20x's are used in one system and are daisy chained through the RS485 bus, the last ARU in the chain needs to have the bus termination jumper placed to terminate it on the correct characteristic impedance, avoiding reflections and guaranteeing a reliable signal transmission.

The bus termination jumper (JP1) is default configured as terminated (meaning only one device connected to the ARU20x's RS485 databus).

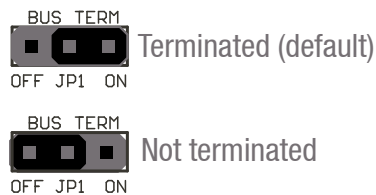

Ground lift jumper:

The input ground contacts are all connected together, and the output ground contacts are all connected together. The in & output grounds can be connected / disconnected with each other through a jumper (JP3). In default configuration, the jumper is configured as 'connected', meaning the in & output ground contacts are connected.

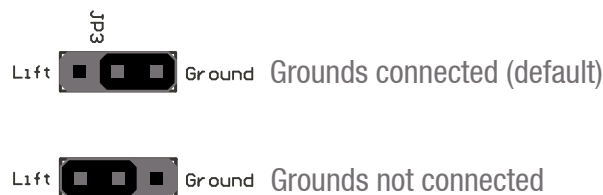

Normal mode / paging mode:

These jumpers (JP2) allow selection of the operation mode between normal and paging mode. The unit is default configured to be used in paging mode.

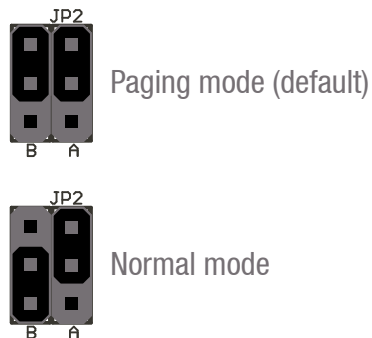

Paging mode: At power-on, all relays will be activated and will be switched to background music mode. In case of power interruption (emergency situation) the relays will return back to their idle state. This configuration is recommended when using the ARU20x in music / paging announcement systems.

Paging mode (music / paging announcement systems)			
Contacts x2 and x2' are paging inputs Contacts x4 and x4' are background music inputs Contacts x1 and x1' are audio outputs			
Paging mode	Relay condition		Audio condition
Power on – output not activated	14 > 11	14' > 11'	Music
Power on – output activated	12 > 11	12' > 11'	Paging
Power off	12 > 11	12' > 11'	Paging
In paging mode, the power off condition is equal to the output active condition.			

Normal mode: At power-on, all relays will remain in idle state and they require a trigger for activation. This configuration is recommended when using the ARU20x for triggering external devices (lights, screens, ...)

Normal mode (e.g lighting control)			
Contacts x2 and x2' are not connected Contacts x4 and x4' are voltage inputs Contacts x1 and x1' are light outputs			
Paging mode	Relay condition		Audio condition
Power on – output not activated	12 > 11	12' > 11'	Off
Power on – output activated	14 > 11	14' > 11'	On
Power off	12 > 11	12' > 11'	Off
In normal mode, the power off condition is equal to the output not active condition.			

Connections overview

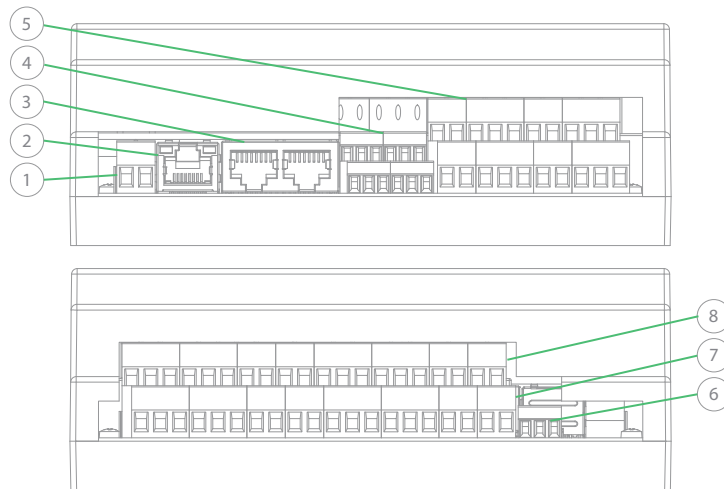

- 1) 24 V DC mains voltage input connection
- 2) Ethernet RJ45 connection
- 3) RS485 databus connection (RJ45) with linkthrough for daisy chaining (only ARU208)
- 4) Contact trigger inputs
- 5) Relay contact outputs
- 6) Analogue audio line out connection (balanced)
- 7) Normal open (NO) relay contact inputs
- 8) Normal closed (NC) relay contact inputs

Chapter 3

Wiring up the system

NOTE

Make sure the power of the system is switched off, when any changes to the connections are being made.

RS485:

In case your system is using the RS485 bus protocol, avoid making any star structured constructions in your cabling. In installations where multiple ARU's are connected in a bus structure it is important that the data bus is connected as a daisy chained structure and the last device terminates the bus on its characteristic impedance through placement of the bus termination jumper. All other devices connected in this bus structure should not have the bus termination jumpers on off position.

The connection between the ARU's (RS485) shall be made with twisted pair cabling (CAT5E or higher). The Ethernet connection shall also be established with CAT5E (or higher) cabling.

Power supply (24 V DC):

The complete system can be powered using a single 24 V DC power supply. The voltage is distributed through the RS485 databus connection and other connected ARU's will be fed accordingly when connected in daisy chained structure. If cable distances larger than 300 meters will occur, the cable length will make the voltage drop below the required level and additional power supplies needs to get added locally.

Ethernet:

To establish a proper Ethernet connection, CAT5E (or higher) cabling needs to be used for connecting the ARU to your Ethernet network.

Relay connections:

Any kind of signals within the systems limitations can be switched and controlled through the ARU unit. Depending on the type of signal and the system regulations or restrictions, the signals needs to be connected using the appropriate cable and wiring standards.

Contact inputs:

The contact inputs on the ARU20x are dry contact inputs which can be used for triggering relays by external devices or actuators. The contacts are triggered by connecting the particular terminal for the relay to ground. When triggering the triggering the 'A' contact, all contacts will switch simultaneously.

Chapter 4

Application examples

Example 1:

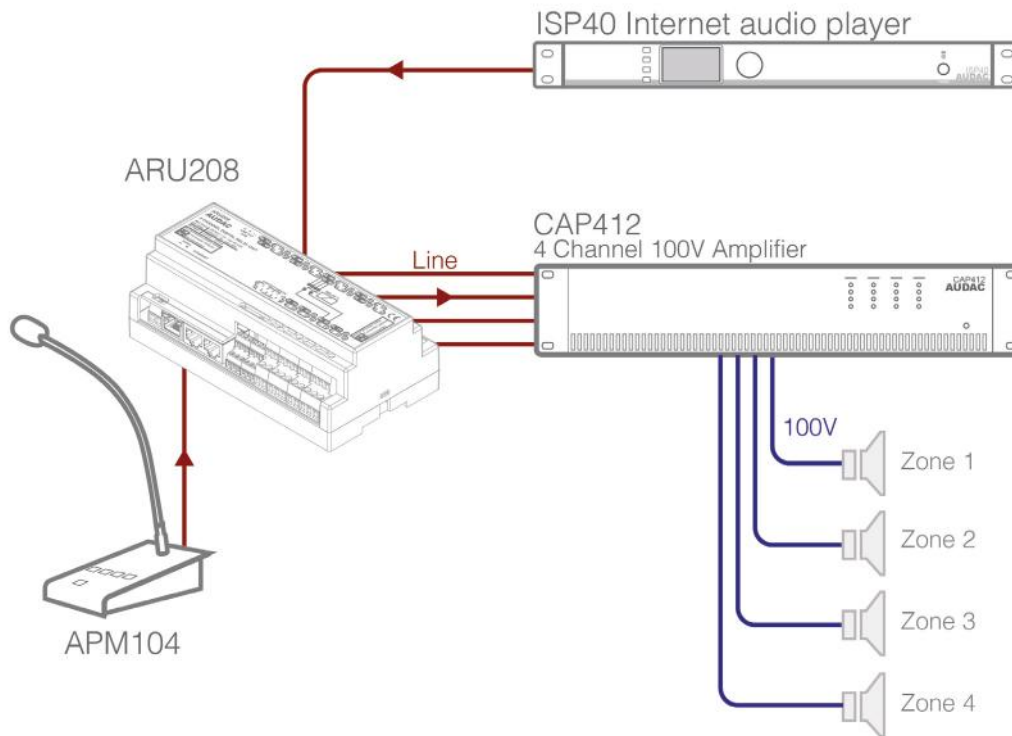

The above diagram shows an example of a simple and basic setup with an APM1xx paging console in an analogue paging setup, combined with an ARU20x relay unit. Besides the APM1xx paging console, a background music source (ISP40 in this typical setup) is connected.

The output of the relay unit is connected to a four channel 100V power amplifier (which also could be four individual amplifiers) for amplification of the signals for each particular zone.

In normal situation, the music coming from the background music source will be heard in all zones (the relays will be switched to background music). In case of an announcement, the ARU will switch to the signal from the paging microphone for the channels which were selected through the APM keypad and the announcement will be heard in the selected zone.

This setup has an individual amplifier (of channel) for each zone, allowing announcements to each zone individually, and allowing the dimensioning of the amplifier power to the requirements for each zone.

Chapter 5:

User interface & configuration

The ARU20x contains a variation of remote control and configuration possibilities. Its functions can be remotely controlled through the embedded web interface. This fully responsive interface based on HTML5 technology can be accessed from any websocket supporting device, offering cross–platform compatibility with Windows, Mac OS, Linux, Android and iOS without requiring any installed applications or web plugins. The fully adaptive structure guarantees a clear viewing on all different kinds of screen sizes.

When application specific or total system control is required, the ARU20x can be controlled using the Audac Touch™ application. This application allows to custom configure your control panel (Dashboard) according to project or user specific requirements.

For using the remote web–control or Audac–Touch interface, the ARU20X shall be connected to an ethernet LAN network and accessed by its IP address. The standard (factory default) IP address of the ARU20X is 192.168.0.197, make sure this address is within the IP range of the connected ethernet LAN network (subnetmask 255.255.255.0).

Start your default web browser and enter the IP address of the embedded web–control interface in the address bar (The factory default IP address is <http://192.168.0.197>)

Login



When accessing the web–control interface of the ARU20x, a password should get entered to control the functions of the system. Two different levels are possible for administrator and user access.

When logging in using the administrator password, full access is given to all systems functions and configuration possibilities. (The factory default password for administrator access is ‘ARU’) When logging in using the user password, restricted access for only the basic functions of the system is given, allowing system control and operation without authorization for making any changes to the system configuration. (The factory default password for user access is ‘user’)

After the correct password is entered, press the 'OK' button, and you will be redirected to the main screen of the web-control interface.

NOTE

If application specific limitations or restrictions for certain functions are required, the system control can be done through the Audac Touch™ freely available application, which allows you to create customized control dashboards.

Dashboard

The dashboard (main) screen gives an overview of all the buttons, which are required for triggering and activating the relays. Depending of the type of relay module, the number of buttons indicated in this screen will vary (4 or 8 relay activation buttons).

On the bottom of the relay knobs, buttons for selecting all (All on) or deselecting all (All off) are located, allowing to switch all relays simultaneously. The knobs will be indicated in a neutral color (grey) when the relays are in the idle state, while they will turn blue when activated.

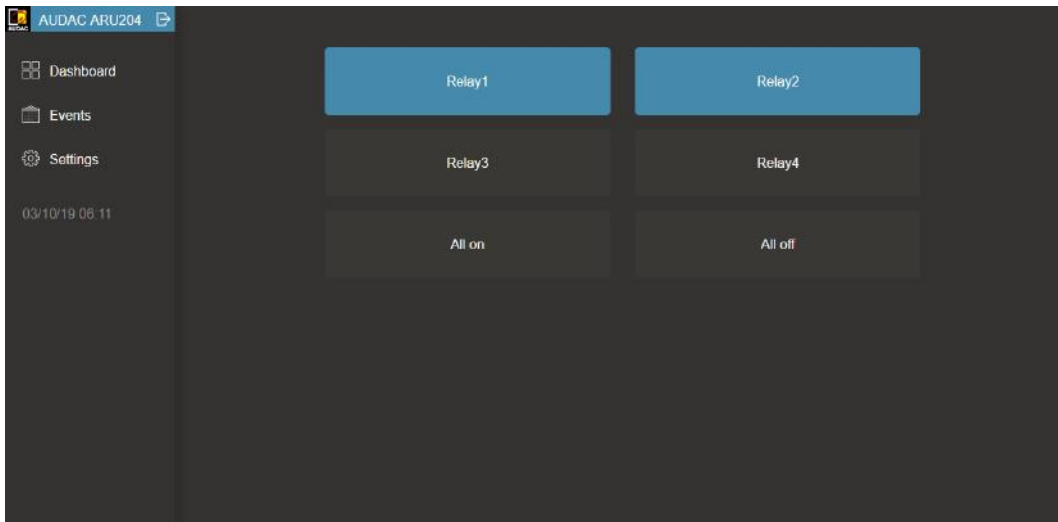

The text inside the relay knob is default shown as 'Relayx' where x represents the number of the corresponding relay (1 up to 4 for ARU204 or 1 up to 8 for ARU208). This text can be adjusted according to customers preferences, allowing to create a more clear and intuitive interface for the user.

The text in the title balk in the top left corner indicates the name which is assigned to the corresponding ARU20x, which allows customizing, for creating a clear and intuitive overview when multiple units are being used in one system. The exit icon inside this title balk logs you off.

Events

The events screen gives an overview and provides the possibility for programming up to 50 timer scheduled actions. Various actions such as switch on, switch off, pulse and radio can be programmed. They can be programmed on single occasions (date) or recurring times (repeat).

NOTE

When using the timer scheduled events functions for the ARU20x, it shall be connected to a network with access to a time server. In default configuration, an internet accessible time server is configured. When access to internet is restricted, an internal network time server shall be assigned.

Action	Pulse (ms)	Schedule	Time	Relay1	Relay2	Relay3	Relay4	
On	N/A	Date 03/10/19	08:00:00	<input checked="" type="checkbox"/>	<input checked="" type="checkbox"/>	<input checked="" type="checkbox"/>	<input type="checkbox"/>	
Off	N/A	Date 03/10/19	12:00:00	<input checked="" type="checkbox"/>	<input checked="" type="checkbox"/>	<input checked="" type="checkbox"/>	<input type="checkbox"/>	
Pulse	10000	Repeat MO TU WE TH FR SA SU	17:00:00	<input checked="" type="checkbox"/>	<input checked="" type="checkbox"/>	<input checked="" type="checkbox"/>	<input checked="" type="checkbox"/>	
Radio	N/A	Date 10/10/19	10:00:00	<input type="checkbox"/>	<input type="checkbox"/>	<input type="checkbox"/>	<input checked="" type="checkbox"/>	

New event Save

Action:

The event which should take place can be selected through the 'Action' drop down list, which is selectable between on, off, pulse and radio. When selecting 'On', the selected relays will be switched in activated status and will remain switched on. When selecting 'Off', the selected relays will be in de-activated status and will remain switched off. The pulse function lets you give a pulse (activation) for a certain period defined in milliseconds and the radio button will activate the selected relays and will switch off non-selected relays.

Pulse:

When the pulse function is selected, the corresponding relays will be activated for a certain period defined in milliseconds. The duration of the activation shall be entered in the 'Pulse' text field. Example given: when the value '10000' is given, the selected relays will remain active for a period of 10 seconds and will return to their idle state afterwards.

The values for the pulse duration shall be within a range of 100 ms and 999000 ms. (with a resolution of 100 ms / step)

Radio:

This function gives you the possibility for activating relays, while all the other relays (non depending of their earlier state) will be switched back to idle state. This function is useful when typically only certain relays at a time is allowed to be activated simultaneously. Select the relays to be activated through the check boxes, and all other relays will be switched to idle state at the set moment.

Date / repeat:

The events can be programmed on single occasions or at recurring (weekly) base. This can be selected by the drop down list through selecting 'Date' or 'Repeat'.

For single recurring events the option 'Date' should be selected and the date shall be entered in the format DD/MM/YY, where DD stands for day, MM stands for month and YY stands for year. The time when the event should take place shall be entered in the format HH:MM:SS, where HH stands for hour, MM stands for minutes and SS stands for seconds. The date shall be entered by manual input into the text fields;

For weekly recurring events, the option 'Repeat' should be selected and the days when the event should take place shall be selected using check boxes which are indicated from Monday (MO) till Sunday (SU).

Relays:

The relays on which the programmed event should take place must be selected. Depending on the used unit, 4 or 8 check boxes will be indicated each of them representing a particular relay of the unit. Mark the check boxes to assign the event for this particular relay.

Save:

When all event settings are made, all events will be saved after clicking the save button on the bottom of the screen.

Settings

The settings screen includes all configurable settings which can be made to the ARU20x. This menu is only accessible in administrator mode.

Device:

In the device settings menu, settings such as the device name and the device address can be configured. The device name is only used for convenience of the users of the system and will be displayed on the top left corner of the main screen. A freely configurable name up to 15 characters can be assigned here.



The device address is an unique address which shall be used when multiple units are daisy-chained with each other and addressed through a single IP address. Each device in the chain should have an unique device address which is selectable between 'S001' and 'S099'.

Additionally the device MAC address and the software version on which its running is indicated in this window.

Network settings:

The network settings can be adjusted in this screen.

The settings are changed by modifying the data which is entered to the text fields and saving the settings afterwards.

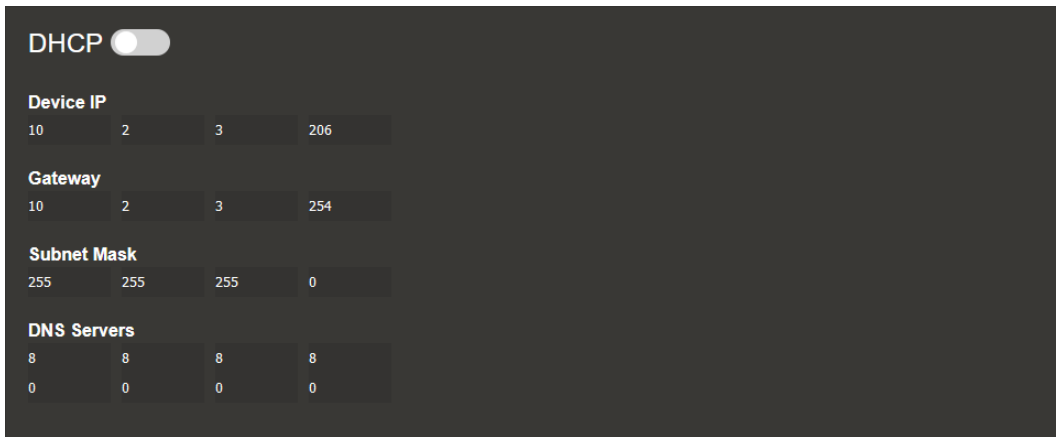

The DHCP function is standard switched off and can be turned one by clicking and enabling the corresponding indicator.

The factory default network settings are as follows:

DEFAULT NETWORK SETTINGS
DHCP: OFF
IP Address: 192.168.0.197
Subnet mask: 255.255.255.0
Gateway: 192.168.0.253
DNS1: 8.8.4.4
DNS2: 8.8.8.8

DHCP:

When DHCP is enabled, the IP address for the ARU20x will be automatically assigned by the DHCP server in your network. It is not always recommended to use this option, since then the IP address of the system will not always be known for the user and might be different after system reboot.

IP address:

The IP address for the system can be configured in this window. Adjustment of these settings is just done by manual changing the values of the text fields.

Network settings:

All other network settings such as subnet mask, Gateway, DNS 1 and DNS 2 can be configured in this window. The default settings are configured in such way to suit most typical installations requirements.

In case of special network restrictions or requirements, consult your network administrator for more details on the network settings.

Delayed startup:

The delayed startup function allows to activate all relays with a specific pre-configured delay time in between activation. This allows you to use the ARU20x as a power-on delay unit, in case heavy loads are connected in your installation with high in-rush currents.



The delayed startup can be activated through enabling the indicated button, and the delay time (the delay between each two relays triggering) can be configured analogue (through a potentiometer located on the ARU20x PCB) or digitally through entering a milliseconds value inside the corresponding text field.

When the value in the text field is set to '0', the value from the potentiometer will be used (indicated as 'POT' underneath)

Time:

When any timer events (timer scheduled) are used in the ARU20x, time synchronization from a time server is required. In default configuration, an internet timeserver is being used which always guarantees an accurate synchronization of the system according to GMT. Depending of the time zone and/or location, the GMT offset settings have to be made accordingly.



In case your system is restricted from access to internet, an internal time server on your LAN network should get assigned offering synchronization to the system. The IP address of the internal time server should be entered in the text field instead of the standard value 'pool.ntp.org'

Relay names:

The relay names which are visible on the dashboard can be changed to create a clear and intuitive overview screen for the user of the system. The relay names can be adjusted by just changing the values of the text fields. A freely configurable name up to 15 characters can be assigned here.

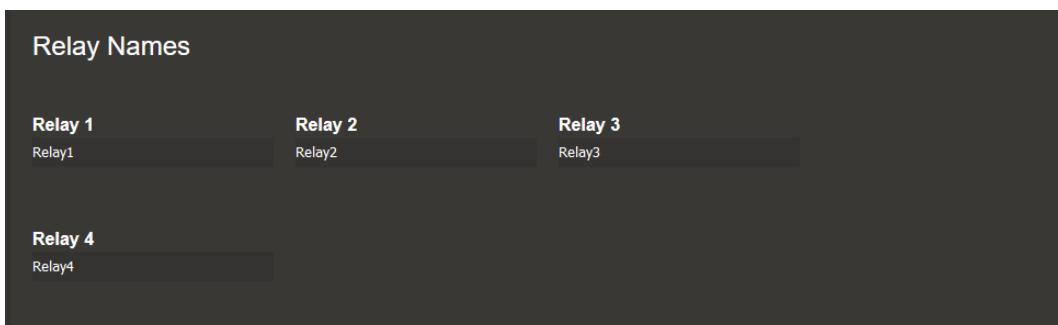

Security:

The password settings for both user and administrator level access can be changed in this screen. The administrator level has access to all functions (including events and settings) while the user level only has access to the dashboard functions.



To change the passwords, click 'change' shown besides the text fields and the new password can get entered. Press enter to confirm and save the newly configured passwords.

SAVE

Any changes made in the settings menu will only be saved after the save button on the bottom of the settings screen is pressed.

Chapter 6

IP Basics

Many AUDAC products are controllable by Ethernet. The Ethernet connection which is used on the AUDAC products is TCP/IP based, like 99% of the computer networks. There are some basics which you need to know to successfully make a TCP/IP Ethernet connection.

The data in TCP/IP networks is always sent in packages, all these packages must be delivered at a unique address, just like the mailman delivers mail at your home mailbox. In TCP/IP networks, this address is called the “IP address”. The IP address is always a number in the following format “192.168.000.001”. As you can see, this address consists of 4 separate numbers ranging from “000” to “255”.

In simple terms, only the latest number of an IP address can be different within a network, so there is a maximum of 254 unique addresses within a network, ranging from “xxx.xxx.xxx.001” to “xxx.xxx.xxx.254”. The first three numbers must be the same to make communication between several devices possible, else the devices can not communicate with each other.

Example:

Device 1:	IP address:	192.168.000.001
Device 2:	IP address:	192.168.000.002
Device 3:	IP address:	192.168.001.003

In this example, Device 1 can communicate with Device 2, but not with Device 3, because the first three numbers must be the same. These first three parts are called the “IP range”, so the devices must be in the same “IP range” to communicate with each other.

The “IP range” of home and office networks are defined by the network administrator, this means that the IP range of your home or office network can be different from another network. AUDAC products have the following IP address as default: “192.168.0.xxx”, this means the standard IP range of AUDAC products is “192.168.000.xxx”. If your network is using a different IP range, the AUDAC products will not be accessible from your network. You can change the IP address of the AUDAC products to make them work properly in your network. This can be done in the settings menu, and is described extensively in the “Settings” chapter of this user manual.

Ask your network administrator for help if you are not familiar with networks.

Summary

- All devices must have a unique IP address
- All devices must be within the same IP range

Each ARU208/4 device is shipped from the factory with a default IP address of 192.168.0.197 in order to connect to the embedded web interface your PC must be within the same range as the device. Find the Ethernet properties settings screen, the new IP address can be set in the Internet Protocol Version (TCP/IPv4). Your PC must have an IP address like 192.168.0.x (x is a value between 2 & 254), the address must be unique. Do not use 192.168.0.197 or any other IP address currently in use. Once saved it is possible using any standard browser to access the web interface using the address 192.168.0.197.

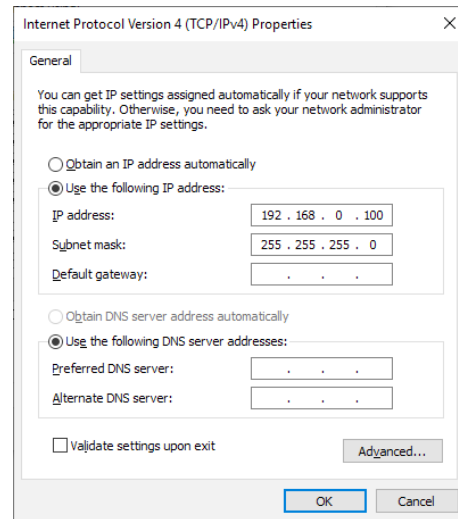
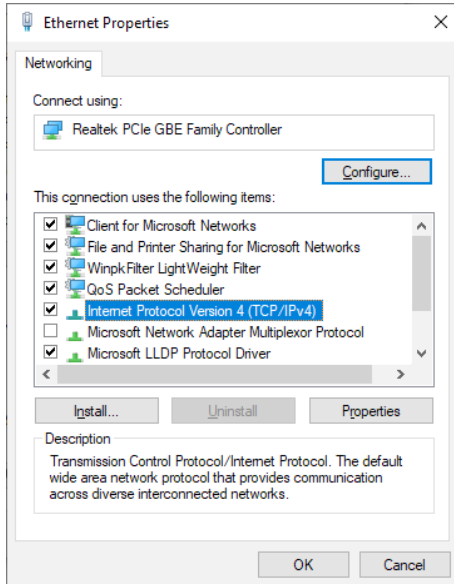

Chapter 7

Technical specifications

Number of relays	ARU204 ARU208	4 x Relays 8 x Relays
Type of relays		DPDT (double pole double throw)
Relay contacts		Normal open (NO) – Double pole Normal closed (NC) – Double pole
Max load per contact		250 V AC / 2A – Max 62.5 VA 24 V DC / 2A – Max 30 W
Control		RS485 Communication bus (RJ45) Manual (contact) relay activation (terminal block) TCP/IP – Ethernet – 10 Mbit (RJ45) Audac Touch™ HTML5 Embedded web–page
Max cable length	RS485 Ethernet	300 meter 100 meter
Connection standard	RS485 Ethernet	CAT5E (or better) TIA/EIA T568B CAT5E (or better) TIA/EIA T568B
Connections	RS485 Ethernet 24 V DC Contact inputs Relay inputs Relay outputs Audio output	RJ45 (2x for ARU208) RJ45 Terminal block connector (max 2.5 mm ² – 14 AWG) Terminal block connector (max 1.0 mm ² – 17 AWG) Terminal block connector (max 2.5 mm ² – 14 AWG) Terminal block connector (max 2.5 mm ² – 14 AWG) Terminal block connector (max 1.0 mm ² – 17 AWG)
Power	Consumption Supply	12W (max) 24 V DC (external 24V DC power supply not included)
Dimensions	ARU204 ARU208	107 x 87.5 x 54 mm (W x H x D) 159 x 87.5 x 54 mm (W x H x D)
Weight	ARU204 ARU208	0.224Kg 0.300Kg
Housing		DIN–rail mountable enclosure ABS constructed (Black)

Notes
