

Highlights:

- Innovative & unique design
- Countless mounting possibilities
- AWX5™ waterproof connector
- Wide opening angle
- Outdoor rated construction
- Multi-tapping 70V / 100V line transformer

Product information:

"Don't feel like hanging around?"

The ALTI6M is a variant of the ALTI pendant speakers, featuring a die-cast mounting bracket for wall & ceiling mount purposes. This allows the same audio system design and identity throughout the entire installation in case some areas are not allowing pendant solutions being used due to the ceiling heights or structures. Acoustics and construction are identically crafted, while connections are made through weatherproof AWX5™ connectors, this construction has an IP65 rating.

The ALTI6M features a 2-way 6,5" driver combination with a coaxially mounted 1" soft dome tweeter and is fitted with a phase plug for excellent off-axis performance. The 2-way combination with a high-quality polypropylene enclosure and acoustic engineering craftsmanship guarantees premium performance for demanding applications. A continuous power handling of 60 Watt (RMS) and maximum power handling of 120 Watt is achieved.

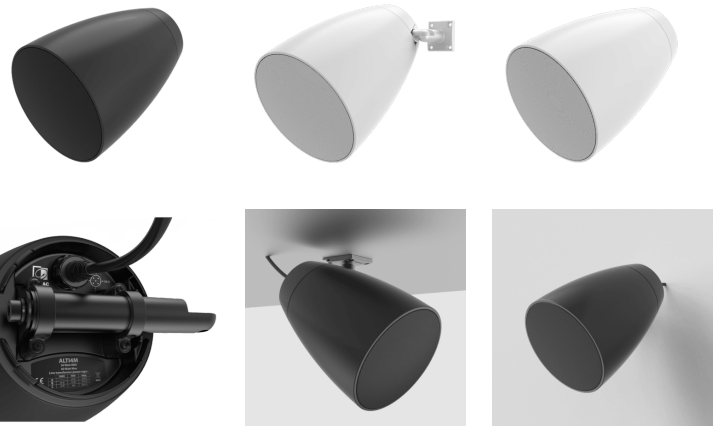

Certification:



Properties:

 Weatherproof

Impedance:

Ω 16 Ohm

Voltage:

 70-100 Volt

System specifications:

Speaker type		2-way coaxial
Peak power handling		240 W
Program power handling		120 W
RMS/AES power handling		60 W
Impedance		16 Ω
Line Transformer Tappings	1	83 Ω - 100 V / Not used - 70 V / 60 W
	2	167 Ω - 100 V / 60 W - 70 V / 30 W
	3	333 Ω - 100 V / 30 W - 70 V / 15 W
	4	667 Ω - 100 V / 15 W - 70 V / 7.5 W
Dispersion	Conical	115° (average 500 Hz to 5 kHz @ -6 dB)
Connectors		Waterproof AWX-5 connector
Sensitivity (1W/1m)		83 dB
Sound Pressure (Max. W/1m)	@ 16 Ω	101 dB
Frequency	Range (-10 dB)	61.5 Hz - 20 kHz
	Response (\pm 3 dB)	75 Hz - 17 kHz
Ingress Protection rating		IP65

Product Features:

Connection cable length		27.56 "
Construction		Polypropylene
Front finish		Aluminium grill
Mounting & handling		2-way Revolving mounting bracket
Weight		7.67 lb
Dimensions		9.25 x 9.055 x 13.23 " (W x H x D)
Accessories	Included	5-pin connection cable (70 cm) AWC07
		2-way Revolving mounting bracket

Variants:

- ALTI6M/B - Black version
- ALTI6M/W - White version

Acoustical data graphs:

Horizontal Polars:

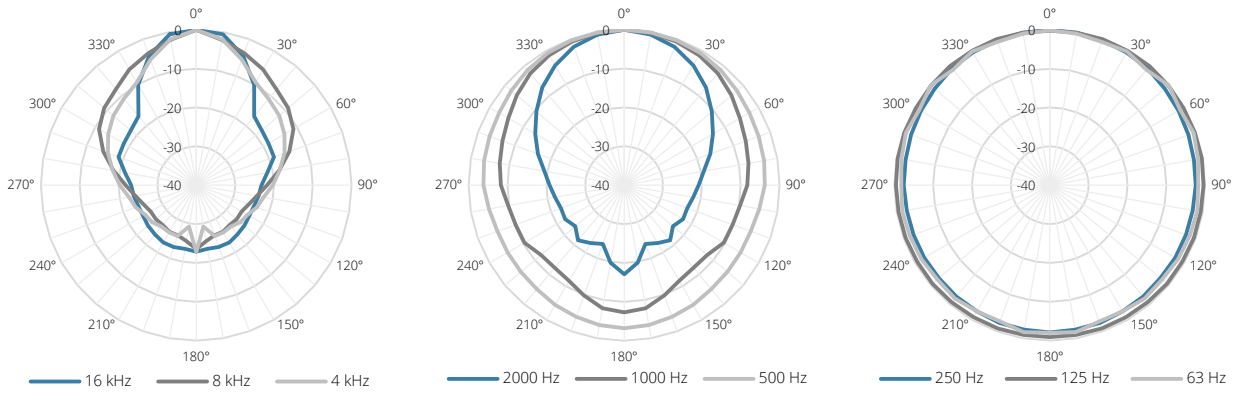

Vertical Polars:

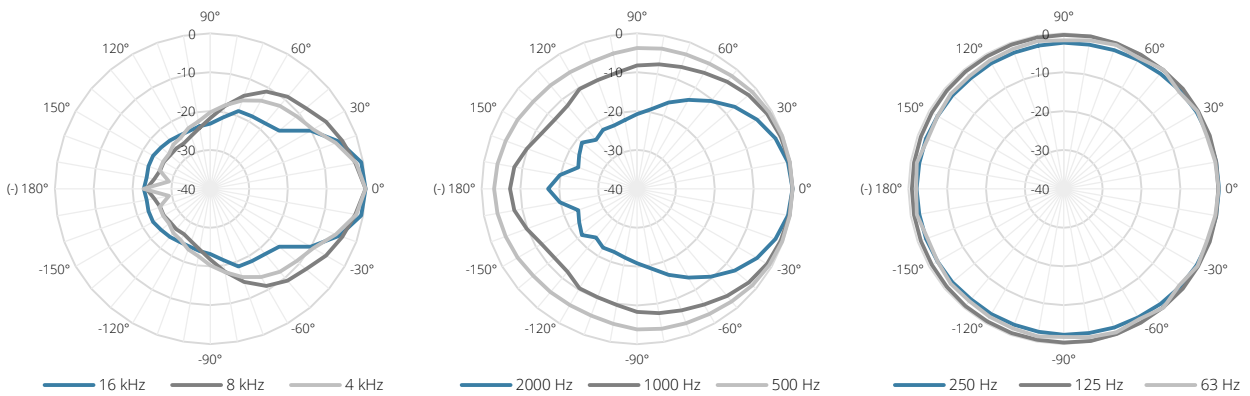

Sensitivity:

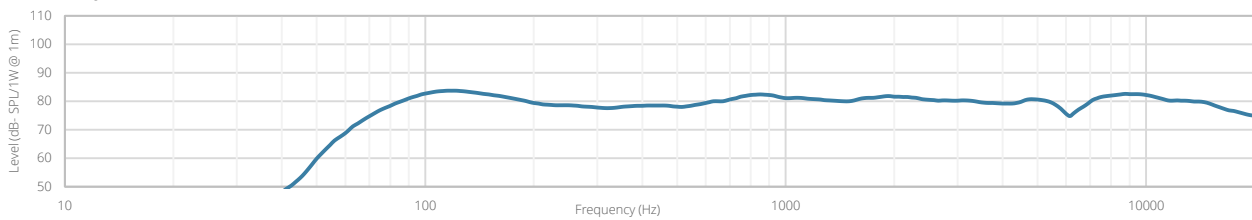

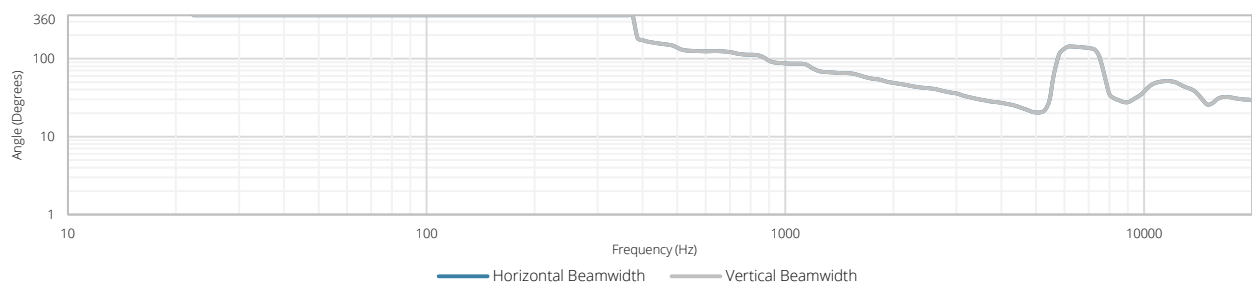

Beamwidth (-3dB):

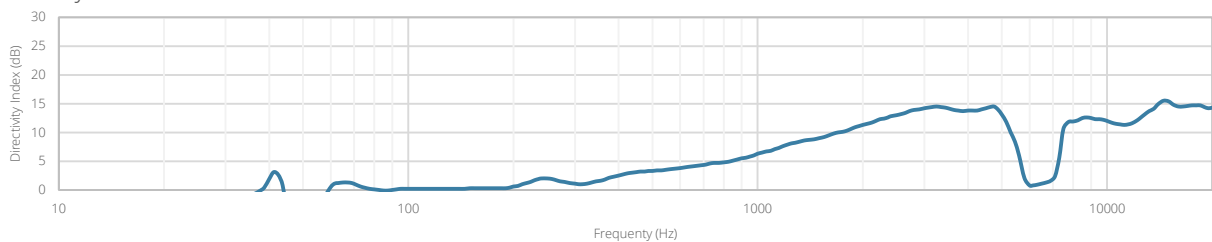

Directivity index:

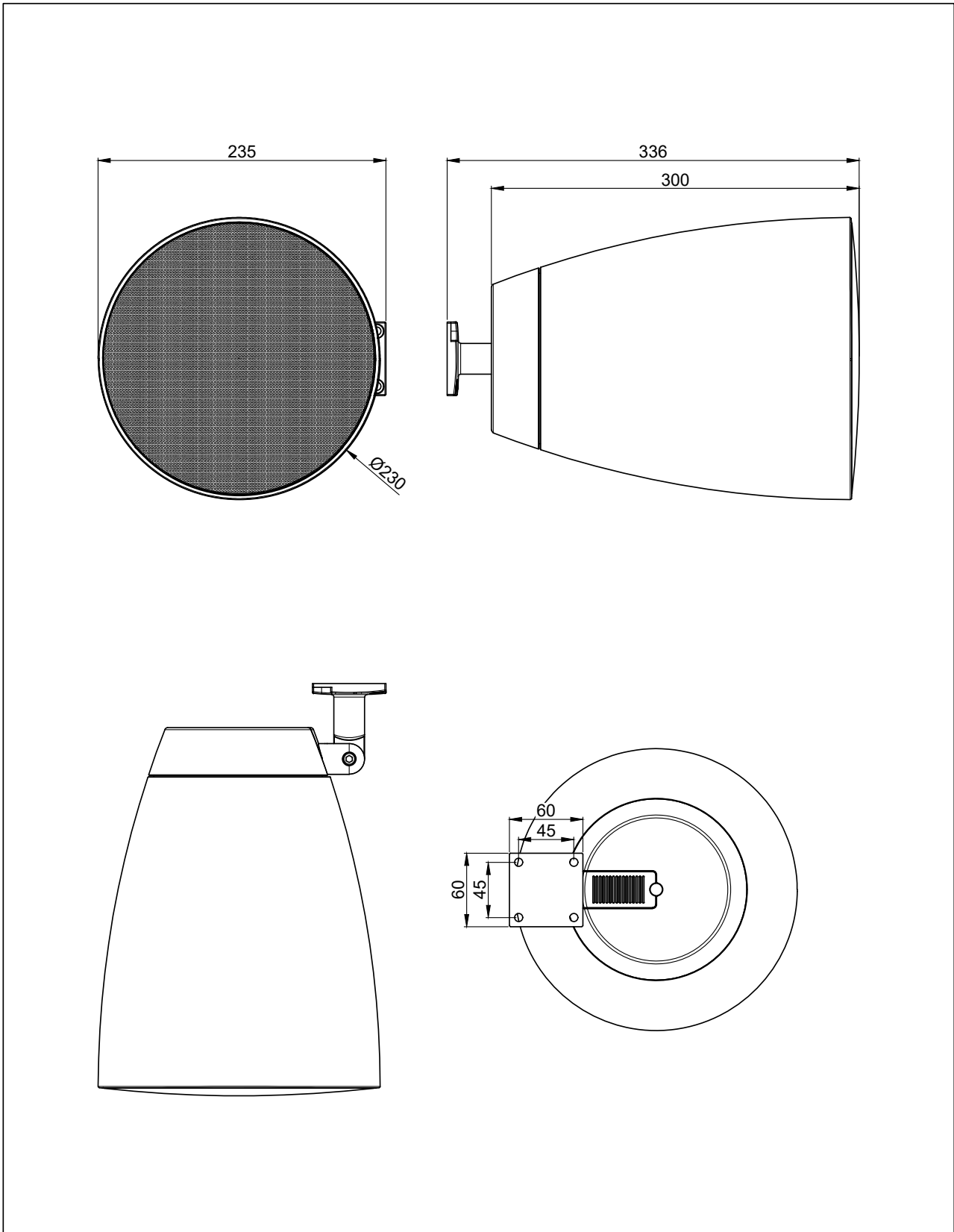



	ALTI6M		Product description: 2-WAY 6.5" PROJECTOR SPEAKER 60W - 70V/100V & 16 OHM
	Weight: 4,12 kg	Outer dimensions: (w x h x d) 235 x 230 x 336	Unit height: N/A